

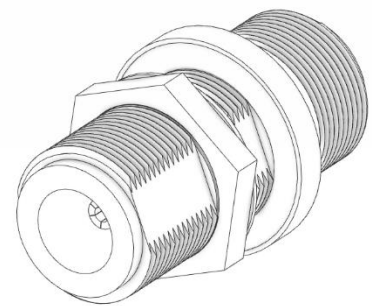

## C5604 N/Female to N/Female Hermetic Bulkhead Adapter 6 GHZ

Rev 001

<b>Electrical</b>	
Frequency	0-6 GHZ
VSWR	1.20
Impedance	75 Ohms
<b>Mechanical</b>	
N Interface per	MIL-STD-348B
Operating Temperature	-40°C to +120°C
<b>Materials</b>	
Body	Nickel Plated Brass
Contacts	BeCu
Contact Plating	Au per MIL-G-45204
Dielectric	PTFE
ROHS Compliant	



Leak Rate :  $1 \times 10^{-7}$  CC/Sec

