



CF0818 SMA/Female Circulator 8.0 – 18.0 GHZ

Rev 000

Electrical	
Frequency	8.0 – 18.0 GHZ
VSWR	1.50
Impedance	50 Ohms
Isolation	14 dB Min
Insertion Loss	1.0 dB
Power Handling	5 Watts
Transmission	Counterclockwise
Mechanical	
SMA Interface per	MIL-STD-348B
Operating Temperature	25°C
Materials	
Body(SMA)	Passivated Stainless Steel
Contacts	BeCu
Contact Plating	Au 50μ" Min
Dielectric	PTFE



Outline

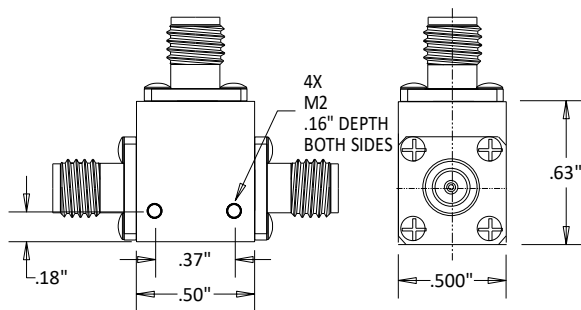

Dimensional Tolerances

.X	±.030
.XX	±.010
.XXX	±.005

Typical Data

