



## CF6012 SMA/Female Circulator 6.0 – 12.0 GHZ

Rev 001

<b>Electrical</b>	
Frequency	6.0 – 12.0 GHZ
VSWR	1.40
Impedance	50 Ohms
Isolation	16 dB Min
Insertion Loss	0.5 dB
Power Handling	5 Watts
Transmission	Counterclockwise
<b>Mechanical</b>	
SMA Interface per	MIL-STD-348B
Operating Temperature	-40°C to +70°C
<b>Materials</b>	
Body(SMA)	Passivated Stainless Steel
Contacts	BeCu
Contact Plating	Au 50μ" Min
Dielectric	PTFE



### Outline

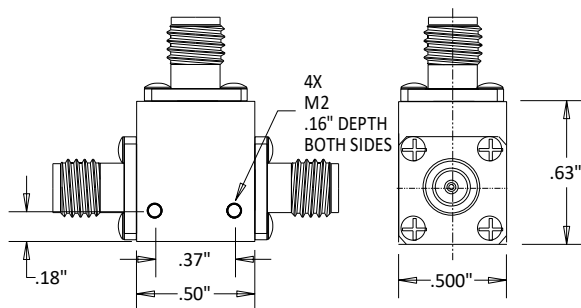

Dimensional Tolerances

.X	±.030
.XX	±.010
.XXX	±.005

### Typical Data

