



CX0869 SMA/Female Solder Connector for RG405

Rev 000

Electrical	
Impedance	50 Ohms
Environmental	
Operating Temperature	-65°C to +165°C
Materials	
Body	Passivated Stainless Steel
Contact	BeCu
Contact Plating	Au 50μ" Min
Dielectric	PTFE
ROHS Compliant	



Outline

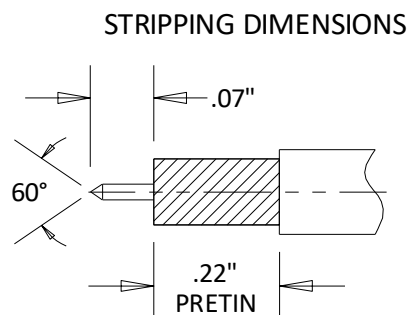
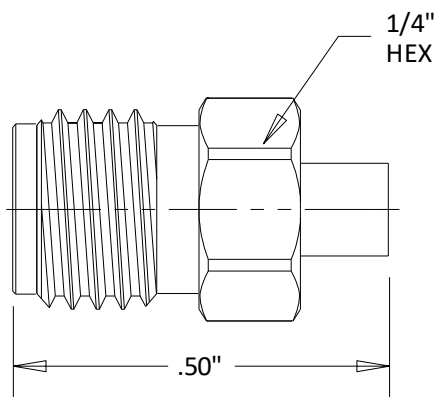

Dimensional Tolerances

.X	±.030
.XX	±.010
.XXX	±.005